

RCA

LED TV

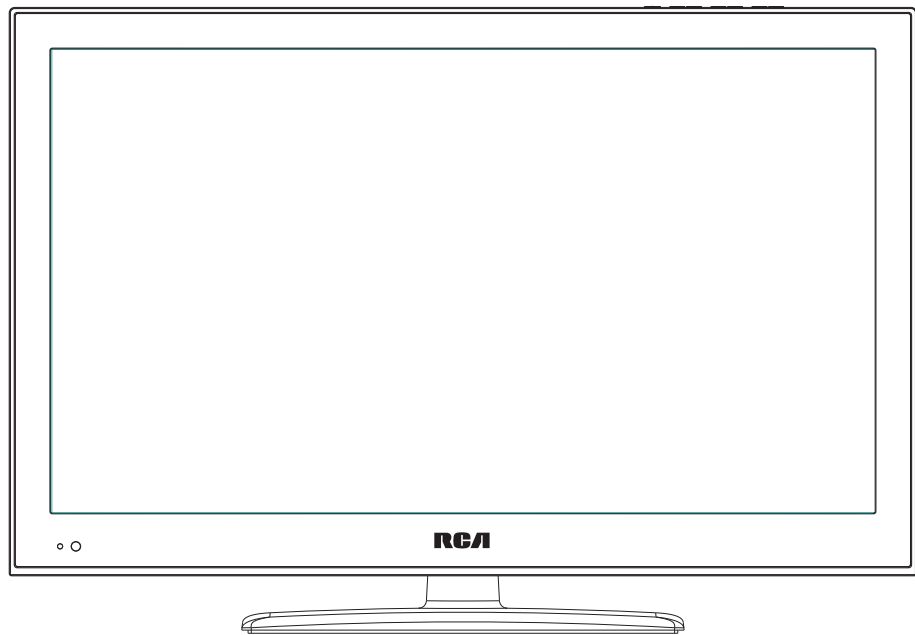

RLEDV2488A



IMPORTANT

Please read this manual carefully before installing and operating the TV
Keep this manual handy for further reference

Table of Contents

Contents	Page
Caution & Important Safety Precautions	1-2
Desktop TV Bracket Installation & Assembly	3-4
Getting Started	5
Front View	5
Rear View	6
Remote Control Key Functions	7
Select input source	8
Main Menu Description	9-10
Picture menu	11
Picture Settings	12
PC Settings	13
Advanced Picture Settings	14
SOUND MENU	15-17
Sound Settings	16
Equalizer Settings	17
CHANNEL MENU	18-21
Channel List	19
Favorite List	19
Auto Channel Search	20
Channel Setting	21
PARENTAL CONTROL	22-26
V-CHIP	23
TV Rating	24
Canada V-CHIP	25
CHANGE PASSWORD	26

Contents

Setup Menu	-----	27
Closed Caption	-----	27
Menu Language	-----	27
Digital CC Style	-----	28
Clock	-----	29
OTHERS MENU	-----	30
Blue Back	-----	30
No Signal Power Off	-----	30
All Reset	-----	30
Audio Only	-----	30
DVD	-----	31-32
Help	-----	33
Specifications	-----	34

Caution



The lightening flash with arrowhead symbol, within an equilateral triangle is intended to alert the user to the presence of un-insulated "dangerous voltage" within the products enclosure that may be of sufficient magnitude to constitute a risk of electric shock to the persons.



The exclamation point within an equilateral triangle is intend to alert the user to the presence of important operating and maintenance (servicing) instructions in the literature accompanying the appliance.



Correct disposal of this Product

Waste Electrical & Electronic Equipment (WEEE)

Your product is designed and manufactured with high quality materials and components which can be recycled and reused.

This symbol means that electrical and electronic equipment, at their end-of-life, should be disposed of separately from your household waste.

Please dispose of this equipment at your local community waste collection/recycling centre.

In the European Union there are separate collection systems for used electrical and electronic products. Please help us to conserve the environment we live in!

Important Safety Precautions

- 1) Read these instructions.
- 2) Keep these instructions.
- 3) Heed all warnings.
- 4) Follow all instructions.
- 5) Do not use this apparatus near water.
- 6) Clean only with dry cloth.
- 7) Do not block any ventilation openings. Install in accordance with the manufacturer's instructions.
- 8) Do not install near any heat sources such as radiators, heat registers, stoves, or other apparatus (including amplifiers) that produce heat.
- 9) Do not defeat the safety purpose of the polarized or grounding-type plug. A polarized plug has two blades with one wider than the other. A grounding type plug has two blades and a third grounding prong. The wide blade or the third prong are provided for your safety, If the provided plug does not fit into your outlet, consult an electrician for replacement of the obsolete outlet.
- 10) Protect the power cord from being walked on or pinched particularly at Plugs, convenience receptacles, and the point where they exit from the apparatus.
- 11) Only use attachments /accessories specified by the manufacturer.
- 12) Use only with the cart, stand, tripod, bracket, or table specified by the manufacturer, or sold with the apparatus. When a cart is used caution when moving the cart/apparatus combination to avoid injury tip-over.



- 13) Unplug this apparatus during lightning storms or when unused for long periods of time.

Caution:

- 14) To reduce the risk of fire or electric shock, do not expose this apparatus to rain or moisture.
- 15) The apparatus shall be disconnected from the mains by placing the power/standby switch in the standby position and unplugging the power cord of the apparatus from the AC mains receptacle.
- 16) The socket-out shall be installed near the equipment and shall be easily accessible.
- 17) This product should never be placed in a built-in installation such as a bookcase or rack unless proper ventilation is provided or the manufacture's instructions have been adhered to.
- 18) The apparatus shall not be exposed to dripping or splashing and that no objects filled with liquid, such as vases, shall be placed on the apparatus.
- 19) Do not place any sources of danger on the apparatus (e.g. liquid filled objects, lighted candles).
- 20) Wall or Ceiling Mounting - The appliance should be mounted to a wall or ceiling only as recommended by the manufacturer.

These servicing instructions are for use by qualified service personnel only. To reduce the risk of electric shock do not perform any servicing other than that contained in the operating instructions unless you are qualified to do so.

Desktop TV Bracket Installation & Assembly

- 1 First put the TV on the table smoothly and put some soft cloth on the table to avoid scratching the screen.
- 2 Use the screw driver to take off the 4 pcs screws which are fixed on the bottom stand (the direction of the arrow, refer to the figure 1, figure 2). And take out the bottom stand (please keep the screws and bottom stand carefully)

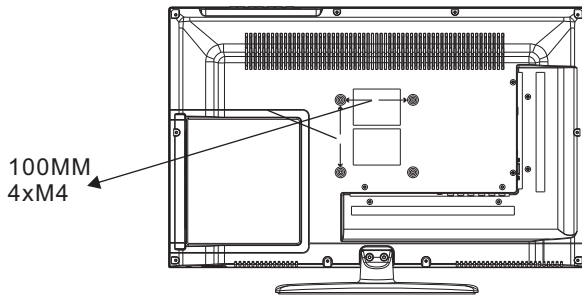

Figure 1



Figure 2

3. Mounting steps (See below figures 1 to 4 for details) :

- Step 1: Decide whether or not to use padding behind the wall mount brackets.
- Step 2: Locate and fix the wall mount brackets with 4 studs into the wooden part of the plasterboard wall, Details see Figure4.
- Step 3: Be sure that the wall mount brackets are level with each other.
- Step 4: Hang the unit on the secured wall mount brackets.
To ensure a reliable and sturdy installation, please consult a professional installer before mounting the unit to the wall.
Moreover, the spacers can be used in combination to adjust unit' s distance from the wall in order to match the mounted Flat-Panel TV. When using the 1/4", 1/2", 3/4", 1" padding, longer screws must be purchased.

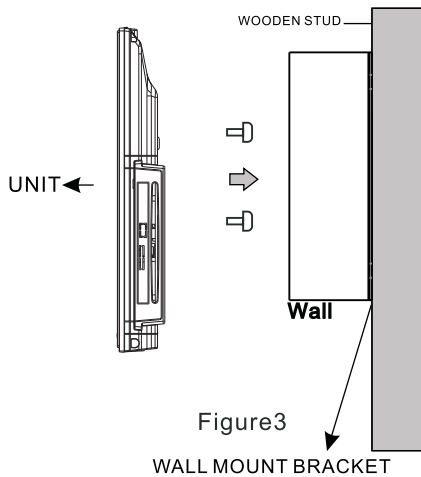

Figure3

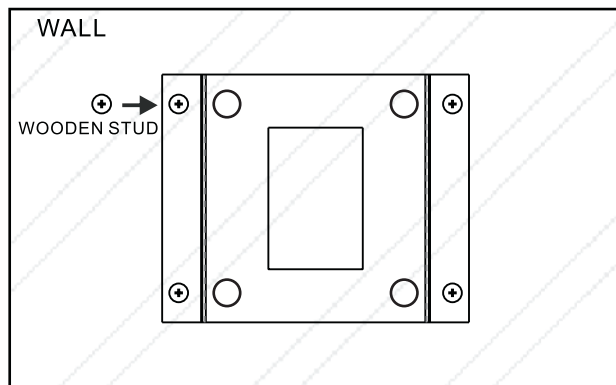

Figure 4

Noted:

- 1.The desktop TV bracket is optional,wall mount is not included in this package.
2. We highly recommend using a qualified technician
- 3.This products can be mounted on the plasterboard wall or other wall more better .

Note: Instruction manual for the TV stand assembly.

1. Match the position hole in the middle of the stand poles to the position holes under the bottom to the TV unit and connect the stand base with the TV unit, the position holes locates between the 2 screws of the stand poles.

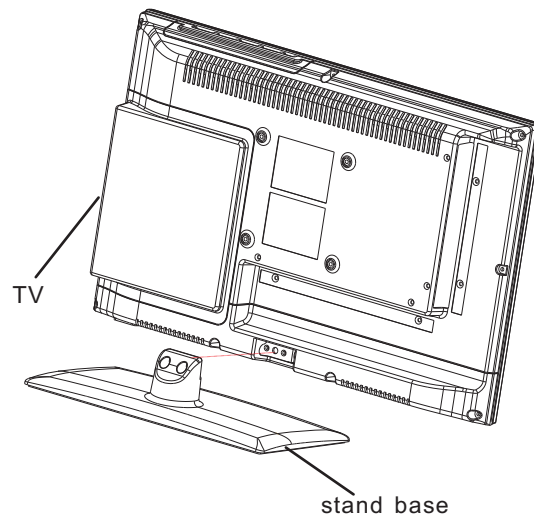

2. Fix the stand and the stand poles with 3 pieces of BM4*10 screws

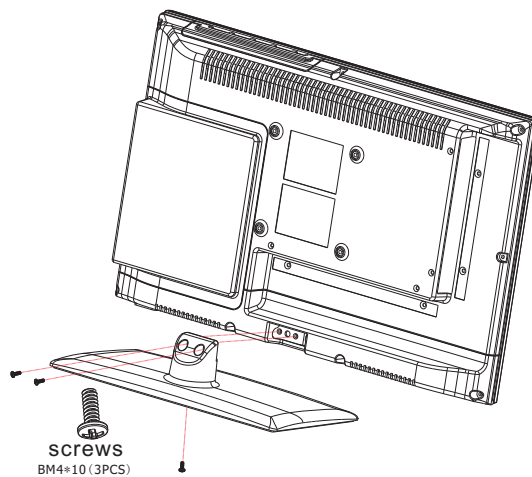

Getting started
Front view

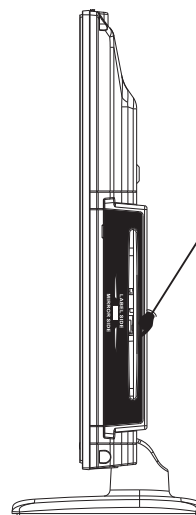
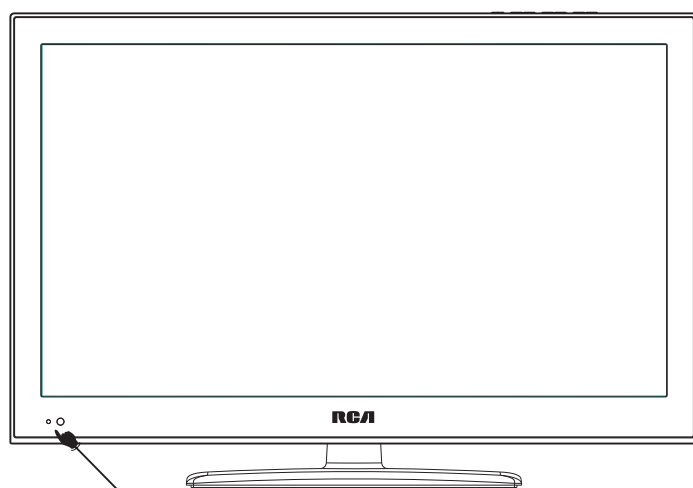

DVD
Insert disc with shiny side facing the front of TV.

(IR) Infrared Receiver: Receives IR signals from the remote control.
(Power on/Standby) LED Indicator: Press to turn on and off

Indicator on(Red)

Standby mode

Indicator on(Green)

Power on mode

The effective receiving scope for the signal is 5-8 meters from the front of the remote control window, and 30° to the left or right side and 20° above or below the control window.

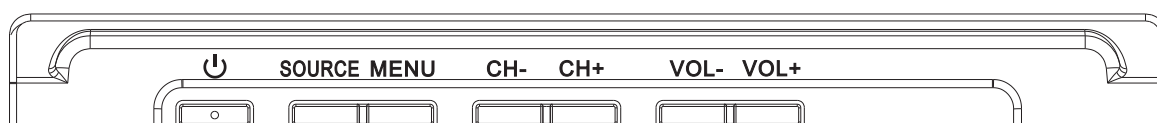

- The functions of the buttons on the TV are as follows:

⏻ : Turn on/standby the TV set.

SOURCE: External signal input selection and confirm the item selected.

MENU:

- 1.Press Menu.
- 2.Press SOURCE to enter.
- 3.Use CH+/- to shift UP/DOWN.
- 4.Press SOURCE to confirm, then press VOL+/-to adjust.
- 5.Press SOURCE to confirm

CH+/-:When watching TV: select channels.

VOL +/-: Press to adjust the volume.

Rear view

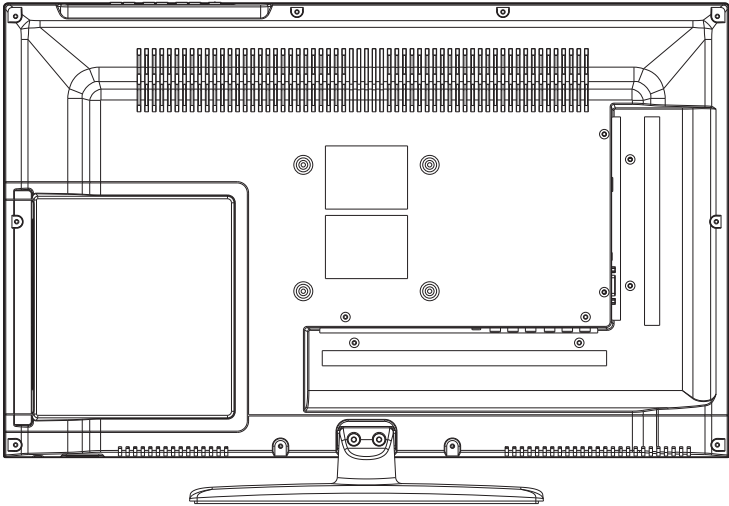

(Left Side)



(Back Side)

Name	Function Description
Service Port	For Upgrade Use.
YPBPR	Connect to the composite terminal of your DVD/VCR
COAXIAL	Digital Audio Output
EARPHONE	Earphone output
PC AUDIO IN	PC audio input
ANT 75 Ω	Connect to ANT or cable source
VGA IN	VGA signal from computer output
AV INPUT	External AV signal input and relevant right/left sound channel
HDMI IN	Connect to HDMI of DVD or other equipment
POWER SOCKET	DC 12V = 4A

Remote Control Key Functions

SLEEP: Select amount of time before TV turn off automatically.

S.MODE: Press to cycle through the different sound settings

P.MODE: Press to cycle through the different picture settings

THUMBSTICK (▲/▼/◀/▶/ENTER)
Allows you to navigate the on-screen menus and adjust the system settings to your preference.

MTS / MP3PROG:
Press to select the audio mode, you can select stereo, Mono, or SAP (second audio program)./When playing mp3 disc, press MP3 PROG and add the favorite music to playlist, press PROG two times to see the programmed playlist.

EPG: Launches the EPG (Electronic Program Guide)

D.Setup: DVD system setup.

CH +/-: Press to scan through or to select a channel.

V +/-: Press to increase / decrease the sound level.

FAV
Set or cancel current channel to be a favourite channel.

FAV+ Down move Favourite program

FAV- Up move Favourite program

▲ DVD eject

|| Play/Pause DVD program.

■ Stop DVD program.

D.MENU: DVD disc menu, press this to access the menu.

D.TITLE: Press to select the DVD title.

GOTO: Play your favorite title/chapter/track.

D.DISP: Press to display the source and channel's info.

PROG
Press this button to change the playback order. It varies according to the different discs.

STEP: Play for single frame image

REPEAT Repeat playing the title or chapter.

A-B During the playback, press this button to repeat playback of a specific section on a disc.

POWER
Set your TV to power on or standby mode.

MUTE
Press to mute the sound. Press again or press VOL+ to unmute.

NUMBER BUTTONS
Press 0-9 to select a TV channel directly when you are watching TV. The channel change after 2 seconds.

0
Press "0" to enter a program number for multiple program channel, such as 2-1 etc.

↺
Return to the previous channel viewed.

MENU
Allows you to navigate the on-screen menus.

SOURCE
Press to cycle through the input source in following:
TV → AV → Y Pb Pr → VGA → HDMI → DVD

DISPLAY
Press to display the source and channel's information.

EXIT
Exit from the menu or sub-menu and cancel the function in progress (if applicable)

▶▶ DVD next chapter.

◀◀ DVD previous chapter.

◀◀ DVD fast reverse.

▶▶ DVD fast forward.

ZOOM In DVD source adjust DVD picture size

ANGLE Select DVD picture angle.

AUDIO Select DVD disc language.

SUBTITLE Select DVD disc subtitle.

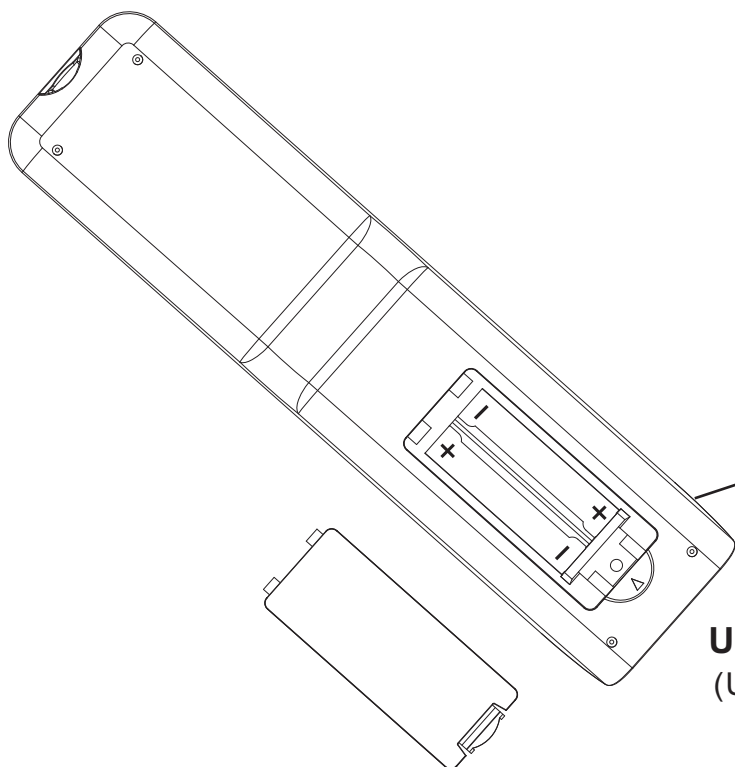

Universal remote code
This is the code for remote control of RLEDV2488A, if you want to change to a universal remote control, you can edit this code into your universal remote control.

- (1) Open the battery compartment cover on the back side
- (2) Insert two 1.5V batteries of AAA type with correct polarity
- (3) Close the battery compartment cover on the back side

Universal Remote Control code: 007F
(Universal Remote control is not included)

SELECT INPUT SOURCE

Input Source



Press SOURCE to display the input source list.
Press ▲/▼ to select the input source and ENTER to confirm.

BASIC OPERATION

Main Menu



Press MENU to display the main menu or return to the previous menu or close the main menu.
Press ◀/▶ to highlight the desired menu icon, and press ENTER to select.

If no buttons are pressed, the menu will close automatically after about 10 seconds.

Main Menu Description

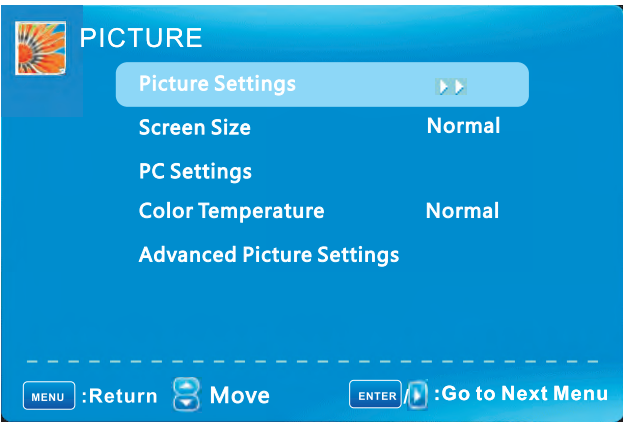
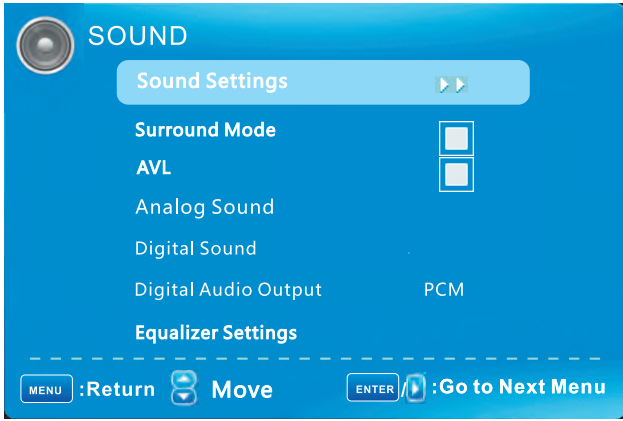
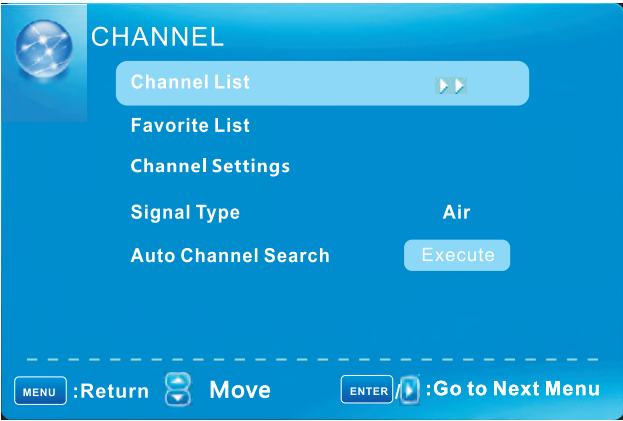
Function	Description
 <p>The PICTURE menu is displayed on a blue background. At the top left is a sun icon. The title 'PICTURE' is in white. Below it, 'Picture Settings' is highlighted with a light blue bar and a right-pointing arrow. Other options include 'Screen Size' (Normal), 'PC Settings', 'Color Temperature' (Normal), and 'Advanced Picture Settings'. At the bottom, navigation instructions are shown: 'MENU :Return', a left arrow icon, 'Move', a right arrow icon, 'ENTER :Go to Next Menu', and a right arrow icon.</p>	<h3>Picture Menu</h3> <p>Adjust your picture settings. The operations are slightly different among different source. For details, see page 11 to 14.</p>
 <p>The SOUND menu is displayed on a blue background. At the top left is a speaker icon. The title 'SOUND' is in white. Below it, 'Sound Settings' is highlighted with a light blue bar and a right-pointing arrow. Other options include 'Surround Mode' (with a square icon), 'AVL' (with a square icon), 'Analog Sound', 'Digital Sound', 'Digital Audio Output' (PCM), and 'Equalizer Settings'. At the bottom, navigation instructions are shown: 'MENU :Return', a left arrow icon, 'Move', a right arrow icon, 'ENTER :Go to Next Menu', and a right arrow icon.</p>	<h3>Sound Menu</h3> <p>Adjust the sound settings. For details, see page 15 to 17.</p>
 <p>The CHANNEL menu is displayed on a blue background. At the top left is a globe icon. The title 'CHANNEL' is in white. Below it, 'Channel List' is highlighted with a light blue bar and a right-pointing arrow. Other options include 'Favorite List', 'Channel Settings', 'Signal Type' (Air), and 'Auto Channel Search' (Execute). At the bottom, navigation instructions are shown: 'MENU :Return', a left arrow icon, 'Move', a right arrow icon, 'ENTER :Go to Next Menu', and a right arrow icon.</p>	<h3>Channel Menu</h3> <p>Customize your channel settings. For details, see page 18 to 21.</p>

Function

Description

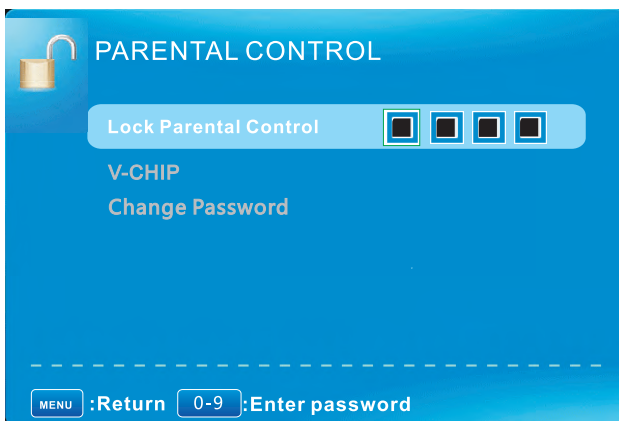

Parental Control Menu

Set program rating control and input source, keypad lock function

For details, see page 22 to 26.

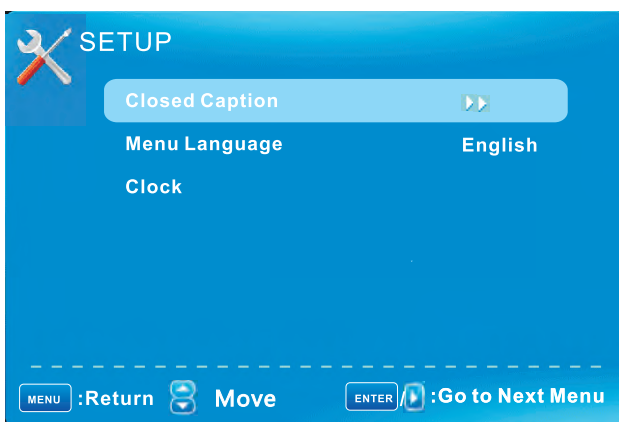

Setup Menu

Select closed caption options, language and time.

For details, see page 27 to 29.



Other Menu

Set the OSD blue background, whether auto power off if no signal or no operation, clear all user settings, etc.

For details, see page 30.

Picture Menu

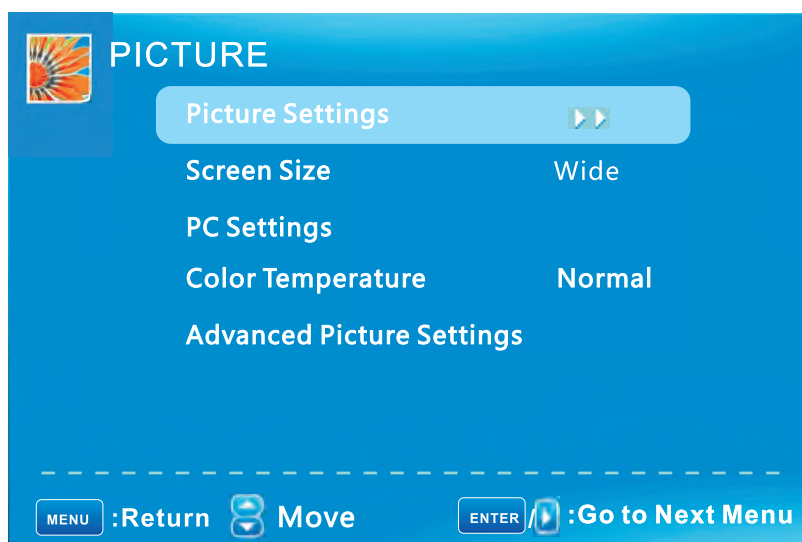

Press ▼/▲ to highlight one of the following options, then press ENTER or ► to enter next sub-menu to adjust it. Press EXIT to clear on-screen menu or MENU back to the previous menu.

Picture Settings Adjust the picture quality including brightness, contrast, color, tint, sharpness. For details, see page 12.

Screen Size Press ◀ / ▶ to select the display aspect ratio till the picture is fit onto the screen. The options are different according to different input source.

PC *Wide/Dot by Dot. Dot by Dot* means NOT any scaling to original input pixels size.

AV/YPbPr/HDMI/TV *Normal/Wide/Cinema/Zoom*. Generally each aspect ratio is suitable for one input format. For example *Normal* is suitable to watch common TV program. *Wide* will do horizontal scaling on the wide panel. *Cinema* is for the 2.39:1 (perhaps marked as 2.40:1 on the disc) film. *Zoom* is suitable to view the analog TV which has wide(16:9) content on the 16:9 panel.

PC Settings The item is available only for PC DB15 or PC DVI input mode, see page 13.

Color Temperature Press ◀ / ▶ to select the color temperature that you feel comfortable.

Normal Basically will be accepted by most people.

Cool means a high color temperature that will feel cool.

Warm means a low color temperature that will feel warm.

Advanced Picture Settings The item is some special picture feature, see page 14.

Picture Settings

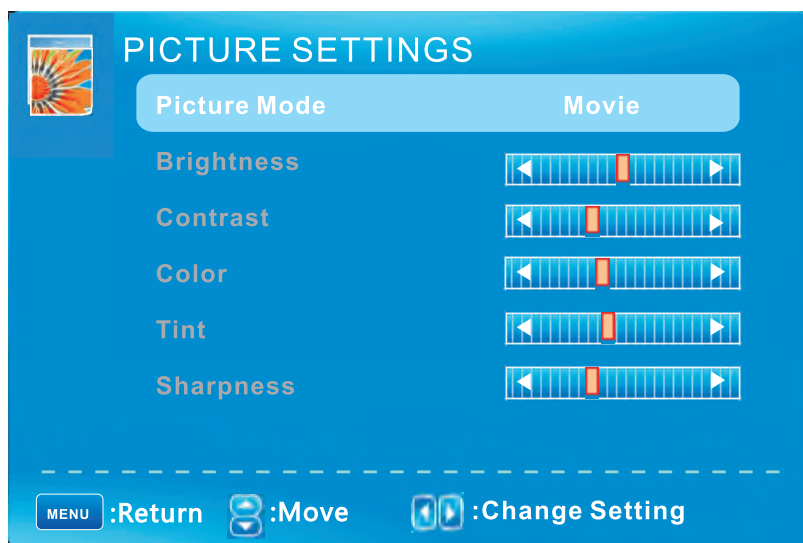

When Picture Mode is set to *User*, the following settings can be manually adjusted.

Press PMODE shortcut button on the remote control to select picture mode directly.

Adjusting the values

Picture Mode

Highlight the item and Press ◀/▶ to select. *Movie/Dynamic/Standard/User*

Brightness/Contrast/Color/Tint/Sharpness

Highlight the item and press ▶, and a process bar appears, then press ◀/▶ to adjust the value. Tint is available when analog TV or NTSC-system AV. Press MENU to back the Picture Settings menu.

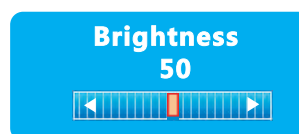

PC Settings

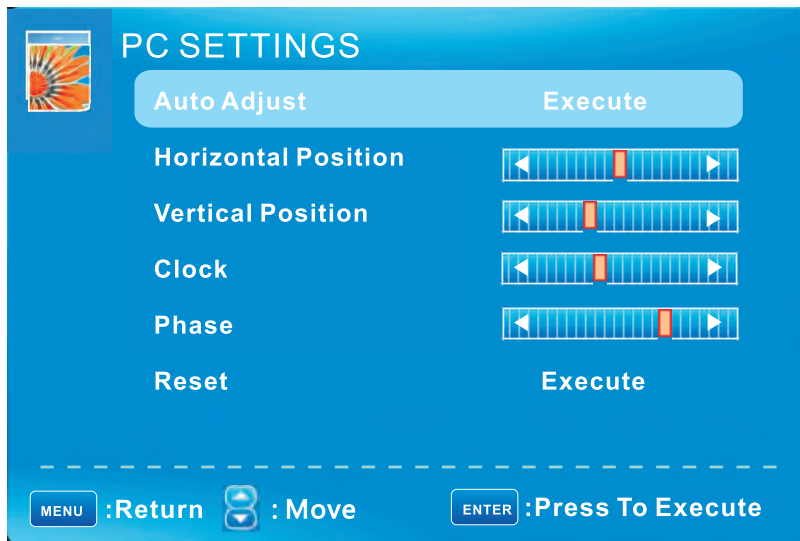

PC Settings Menu is available only in PC DB15 or DVI mode. When DVI signal input, only *Horizontal Position* and *Vertical Position* can be adjusted.

Press ▼/▲ to highlight one of the following options, then press ENTER to select it.

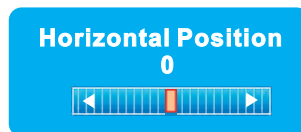

Auto Adjust Automatically adjust Clock, Phase, H-Position and V-Position settings. In order to get a good result, you should open a "filling the screen" picture before executing *Auto Adjust*.

Horizontal Position Shift the screen slightly to left or right .

Vertical Position Shift the screen slightly up or down.

Clock Adjust the DB15 picture signal sampling clock rate.

Phase Adjust the DB15 picture signal sampling phase. It maybe affect the definition . Wrong value maybe result the interference.

Reset Reset the parameters of current menu to default value.

Advanced Picture Settings

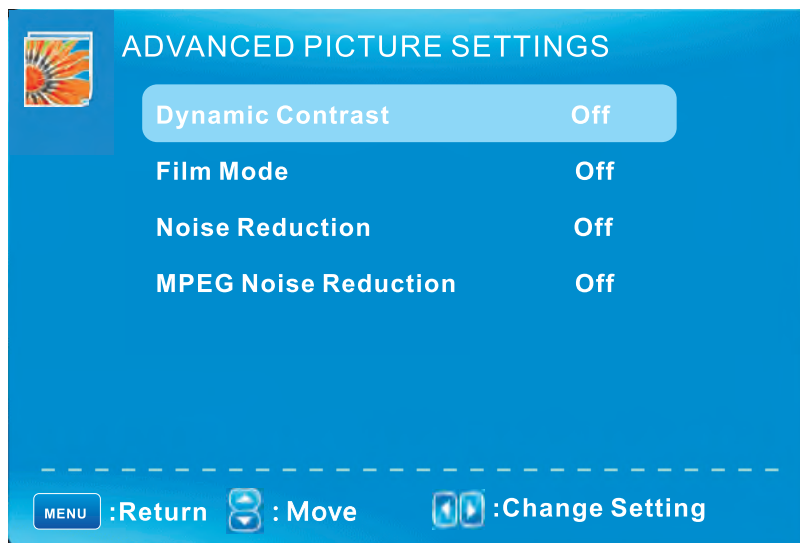

Press ▼/▲ to highlight the item and press ENTER or to display the sub-menu as following.

Dynamic Contrast *Off/Low/Medium/High*

The system will adjust the luminance curve by analyzing the picture content dynamically.

Film Mode *Off/On*

For the 2:2 or 3:2 format signal of cinema , enable special pixel process to reduce the flick of moving area.

Noise Reduction *Off/Low/Medium/High*

You can clear up analog TV signal by reducing the dot noise. This feature is not available at PC or Media source.

MPEG Noise Reduction *Off/Low/Medium/High*

Similar with the *Noise Reduction*, you can set to reduce the block noise.

Sound Menu

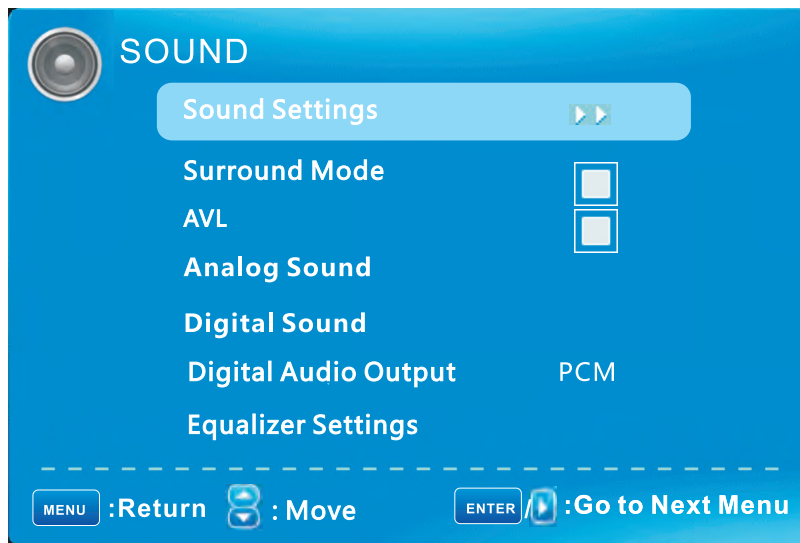

Sound Settings Set the sound mode, and *Bass/Treble/Balance*, see page 16.

Surround Mode Set to enjoy the virtual surround sound. Press ENTER to set or cancel.

AVL Auto Volume Level. Press ENTER to set or cancel. When AVL is set on, it will limit the sound being heard when sudden changes in volume occur during commercial breaks or channel changes. Usually be enabled at night.

Analog Sound Available at analog TV channels. *SAP/Stereo/Mono*
Set the preferred sound track of analog channels. Stereo and SAP exist on some channels. Generally SAP is a second language sound or help the people with hearing impair.

Digital Sound Available at digital TV channels. *English/French/Spanish*
Set the preferred sound track of digital channels. French and Spanish exist on some channels.

Digital Audio Output *PCM/Raw/Off*
Set the audio output type of coax or optical terminal. *Raw* means output the original format of audio stream. *PCM* can be matched with most AV amplifiers.

Equalizer Settings Adjust the curve of 7 bands equalizer, see page 17.

Sound Settings

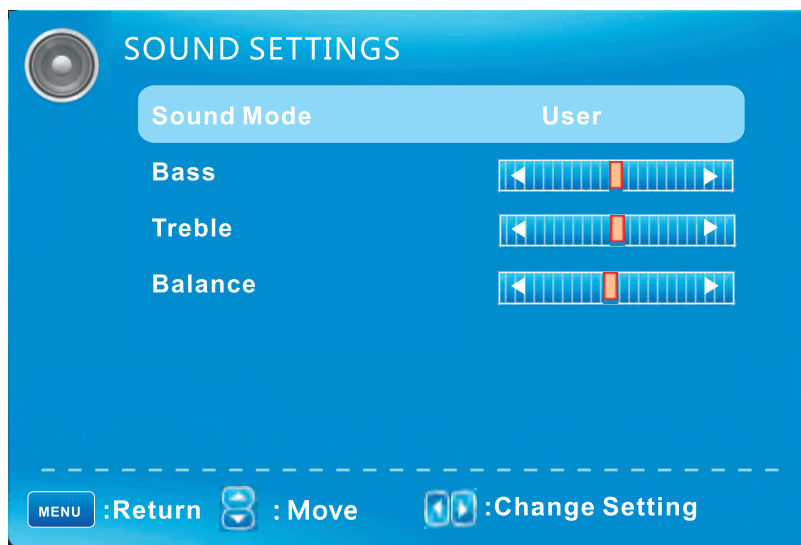

Sound Mode *Standard/Dynamic/Soft/User*

Only in User mode, the follow items can be adjusted.

Bass Adjust the low frequency band response.

Treble Adjust the high frequency band response.

Balance Adjust the level of sound coming from the left or right speaker.

Adjust the Bass/Treble/Balance

- 1 Set Sound Mode to *User*.
- 2 Highlight the item and press ▲/▼ to display the sub-menu, then press ◀/▶ to adjust the value.

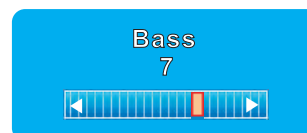

Equalizer Settings

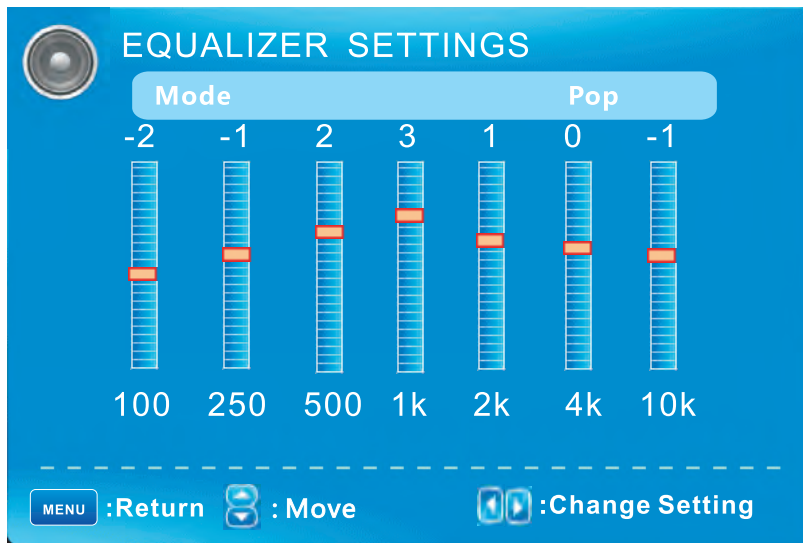

Mode Off/Rock/Pop/Jazz/User(only in User mode, the following can be manually adjusted.)

Adjust Equalizer Settings

Based on your favorites about which frequency band need to be adjusted, make small adjustment with certain frequency band at a time. Suggest NOT making too large changes.

- 1 Set Mode to *User*.
- 2 Press ▼ to select the first(100Hz) item, then press ◀/▶ to select the band to be turned.
- 3 Press ▼/▲ to adjust the value.

Channel Menu

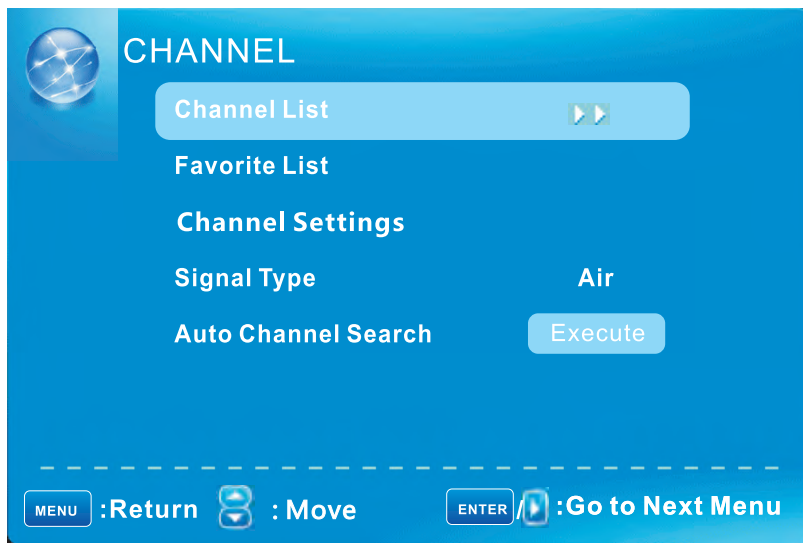

Note: The menu is available only at TV source.

Channel List You can view all the channels and choose one quickly. For details of setting, see page 19.

Favorite List All of you favorite channels are listed in this menu, and you can choose them quickly. For details of setting, see page 19.

Channel Setting Set the favorite channels, skipped channels, label of channels, see page 21.

Signal Type Set to *Air* or *Cable* according to your antenna source. When set to *Air*, TV can catch 8VSB broadcasting signal. When set to *Cable*, TV can catch analog and clear 64QAM/256QAM broadcasting signal.

Auto Channel Search Highlight and press ENTER to start the auto searching, see page 20.

Channel List



"ABC" : Label of the Channel .

Press ▼/▲ to highlight a channel and press ENTER to view it.

Favorite List

The list shows channels that you set as favorite.

See " Channel Settings" on page 21 to understand how to set channels be favorite.



Auto Channel Search

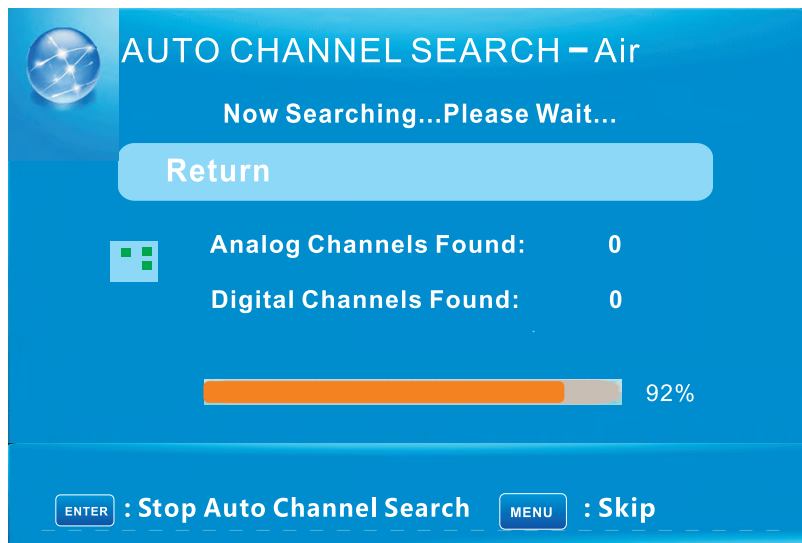

It will search analog channels first, then digital channels.

Before execute auto channel search, please confirm your antenna type is *Air* or *Cable*. Wrong setting of *Signal Type* maybe cause finding no channel. Found numbers do not include encryption programs.

Channel Settings

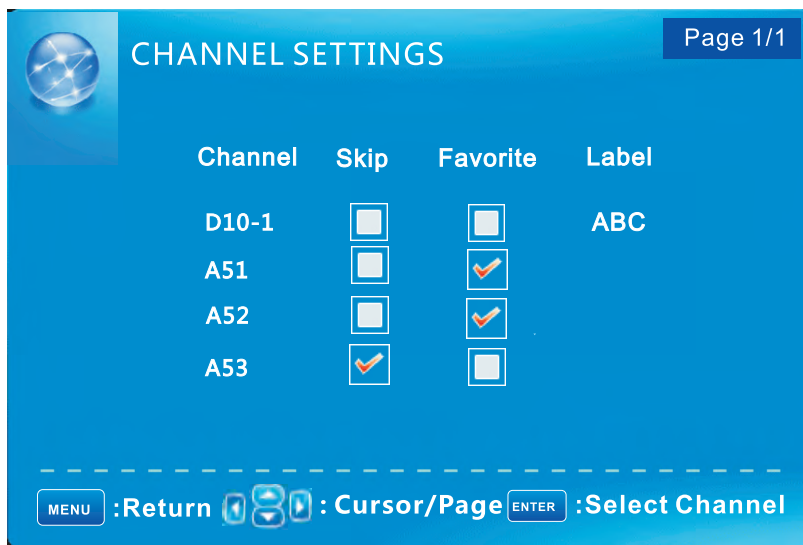

Skip Set the channel to be skipped when using CH+/Ch- to view channels.

Favorite Set the channel to your favorite list.

Label Rename label of the channel.

Change the settings

Skip & Favorite

- 1 Press ▼/▲ to select the channel you want to set.
- 2 Press ◀/▶ to highlight corresponding item, and press ENTER to set or cancel.

Label

- 1 Press ▼/▲ to select the channel and ENTER to enter the edit state.
- 2 Press ▼/▲ to select the character, press ◀/▶ to move the cursor. Total seven letters.

Parental Control

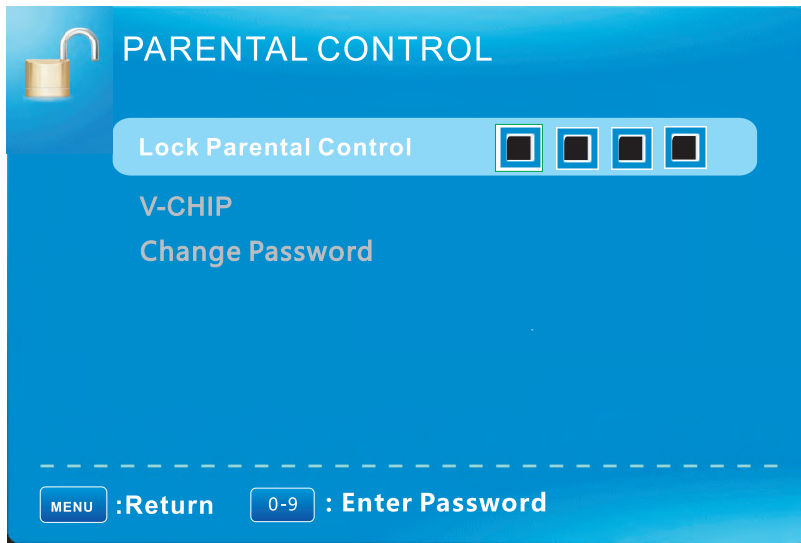

Note: The default user password is "0000" , and if forget what you set, try "1470" .

Lock Parental Control The following items are only available if the password input is correct.

V-CHIP Include below settings:

US V-Chip Rating system used at USA. See page 23.

Canada V-Chip Rating system used at Canada. See page 25.

Block UnRated Show Control whether lock the program that have not any valid rating flag.

Downloadable Rating Control the RRT5 setting which are valid only at some digital cable channels.

Clear Downloadable Data Select to clear the previous downloadable rating data.

Change Password Page26

US V-CHIP

For the United States, the rating setting basically include the following options: Movie Rating, TV Rating. (For Canada, see page23)

Moive Rating

This system defines the rating control which come from MPAA rules.



Rating	Define
G	General audience. All ages admitted.
PG	Parental guidance suggested. Some material may not be suitable for children.
PG-13	Parents strongly cautioned. Some material may be inappropriate for children under 13.
R	Restricted. Children under 17 require accompanying parent or adult guardian.
NC-17	No one 17 and under admitted.
X	Adult audience only.

TV Rating

The TV rating compose of two aspects: age-based and content-based.

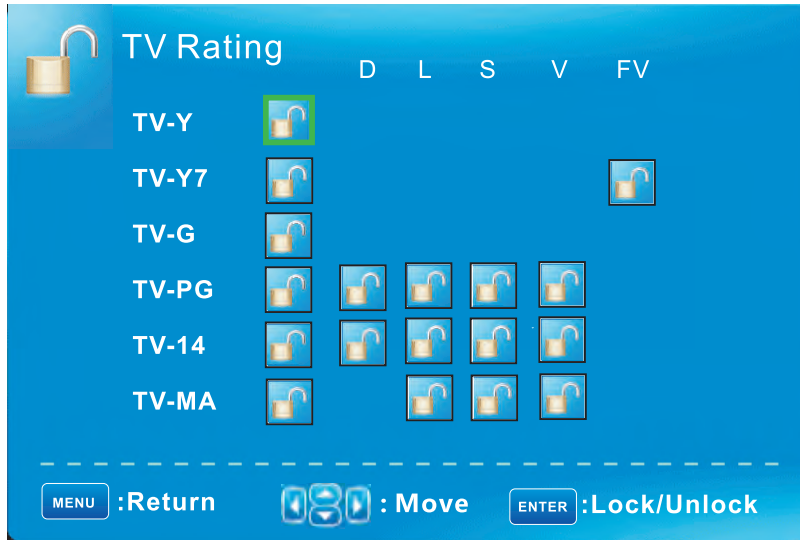

Age	Define
TV-Y	General audience
TV-Y7	Parental guidance suggested
TV-G	Parents strongly cautioned
TV-PG	Retricted
TV-14	No one 17 and under admitted
TV-MA	Adult audience only

Content	Define
FV	Fantasy violence
D	Suggestive dialogue
L	Strong language
S	Sexual situations
V	Violence

Note: The content ratings will increase depending on the level of the age-based rating. For example, a program with a TV-PG V(violence) rating may contain moderate violence, while a TV-14 V(violence) rating may contain intense violence. So locking a higher level option will automatically cause locking the options that has more sensitive level.

Canada V-CHIP

For Canada, the rating setting include the following options: English Rating, French Rating. (For the United States, see page 22)

English Rating

These ratings are for programs which are using English rating system.

Rating	Defined as
C	Children
C8+	Children 8 years and older
G	General programming
PG	Parental guidance
14+	Viewers 14 and older
18+	Adult programming



French Rating

The ratings are for programs which are using French rating system.

Rating	Defined as
G	General
8 ans+	Not recommended for younger children
13 ans+	Not recommended for children under age 13
16 ans+	Not recommended for ages under 16
18 ans+	This program is restricted to adults

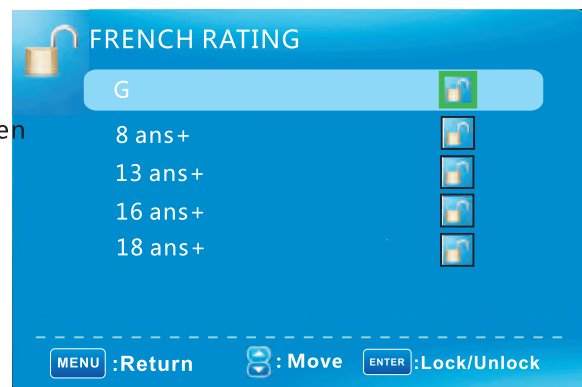

Change Password

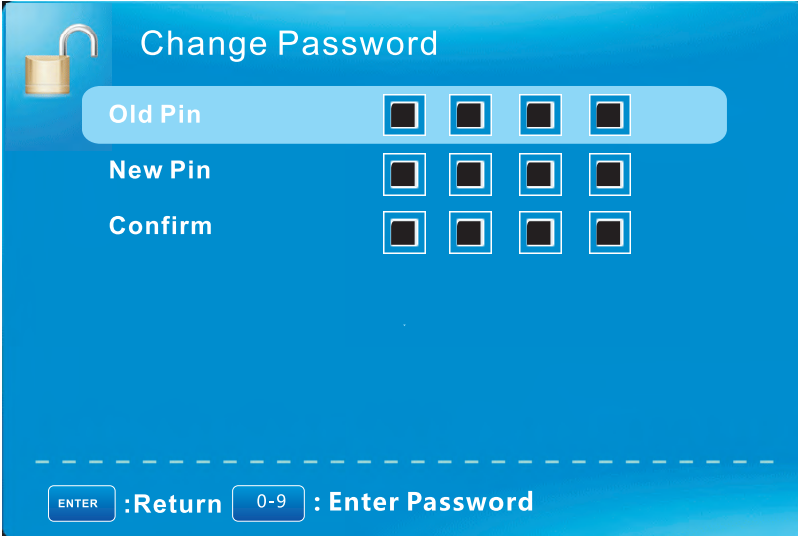

The image shows a blue screen titled "Change Password" with a padlock icon. It features three rows of input fields, each with four black boxes for digits. The first row is labeled "Old Pin", the second "New Pin", and the third "Confirm". At the bottom, there are two buttons: "ENTER :Return" and "0-9 : Enter Password".

At first you should enter the correct old password then enter new password twice. If you lost your password, try to enter "1470".

Setup Menu

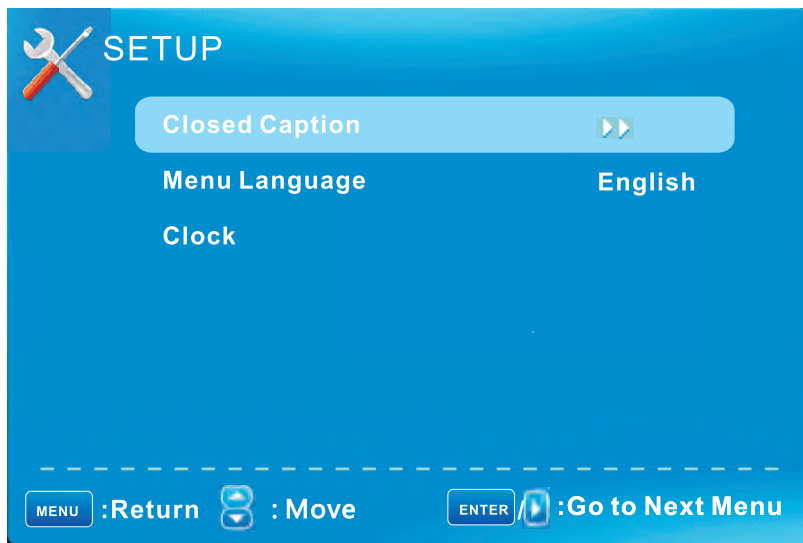

Closed Caption(CC) Include below options:

Caption Display Display or hide the CC .

Analog Caption Type Select from below closed-caption modes for analog programs.

CC1,2,3,4 Displays corresponding caption channel of a analog program.(Usually be set to CC1 for most programs.)

Text1,2,3,4 Displays corresponding text service channel of a analog program.

Digital Caption Type Applies only to digital channels with closed caption.

Service1,2,3,4,5,6 These are different service data channels.

Digital CC Preset *Default/Custom*

If set to *Custom*, *Digital CC Style* is available.

Digital CC Style

Menu Language Set the menu language. *English/French/Spanish*.

Clock Set the *Time Zone/Auto Clock/Day of time/Daylight Saving*, see page 29.

Digital CC Style

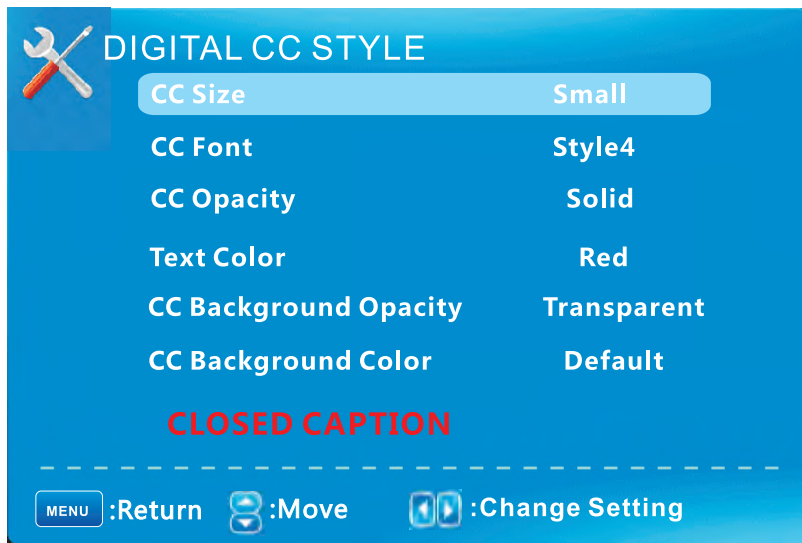

This menu is valid only for digital closed caption of digital channels.

CC Size *Small/Standard/Large/Default*

CC Font *Style0~7,Default*

CC Opacity *Flashing/Default/Solid/Translucent/Transparent/Default*

Text Color *Blue/Yellow/Red/Black/White/Green/Magenta/Cyan/Default*

CC Background Opacity *Flashing/Solid/Translucent/Transparent/Default*

CC Background Color *Blue/Yellow/Red/Black/White/Green/Magenta/Cyan/Default*

Clock

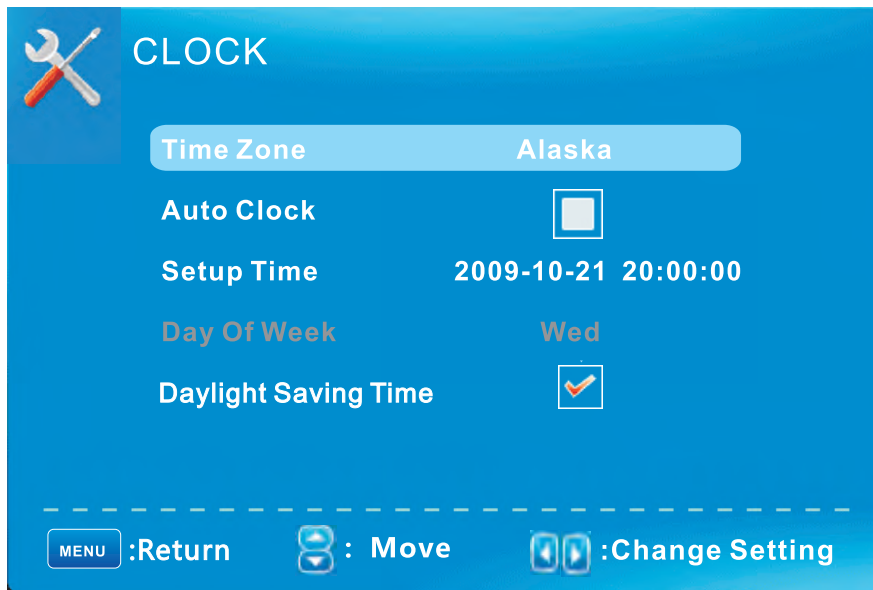

Time Zone *Hawaii/Alaska/Pacific/Central/Mountain/Eastern/Samoa/Newfoundland/Atlantic*

Auto Clock If set it to *ON*, the TV will sync the local clock according to the DTV broadcasting time automatically. Otherwise you can set the time manually.

Setup Time Set Auto Clock to *Off*, then you can set the time manually .

Note: In the case of loss of power, the clock setting will be lost.

Day of Week The TV will calculate current day of week according to the time.

Daylight Saving Time When Auto Clock set to *ON*, this item is available to enable daylight saving option or not.

Ohters Menu



Blue Back Set the screen background color blue or not when no valid signal input. When analog TV input and has no signal, snow noise will display if this option is cleared.

No Signal Power Off If it is set, TV will automatically enter standby after 10 minutes without signal input.

No Operation Power Off If it is set, TV will automatically enter standby after 3 hours without any operation.

All Reset When you highlight the item, the system will note you that “ **Attention! If [All Reset] was executed, TV system is reset**” , and if you are sure to reset, press ENTER to reset .

Audio Only When you highlight the item, the system will note you that “ **Attention! Hold on power key 3 second to restore video**” , and if you are sure not need to view (backlight is turned off), press ENTER to confirm. As the attention, if you want to wake up the video, please hold on the power button for 3 seconds.

DVD

DVD SETUP

Press the “D.Setup” button to enter the DVD settings menu, use the “◀/▶” buttons to select the desired menu page (General / Audio / Dolby / Video / Preferences), and use “▼/▲” buttons to select the items in each menu, then use “▶” button to enter the selected item. If you then change any setting, press “ENTER” button to confirm the value you changed. Press the “◀” button to return to the left submenu; to go back up to one of the main DVD menu pages, press “EXIT” button.

1. General Setup Page

Osd Language: Set the language of the setup menu and screen display.

Screen saver: Set the screen protection.

Last Memory: Remember and resume from the position of the previous playback.

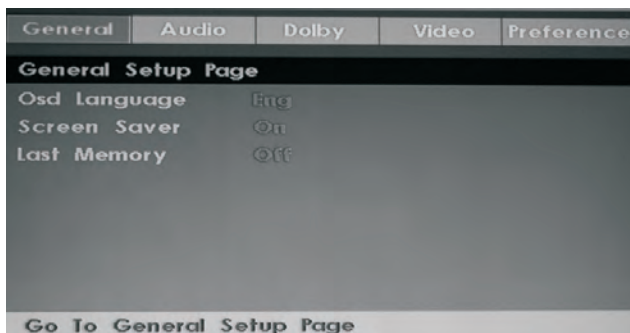

2. Speaker Setup Page

Downmix: This is DVD L/R and stereo output, default as stereo output.



DVD

3. Dolby Digital Setup

Dynamic: Adjust sound dynamic range



4. Video Setup Page

Sharpness: adjust the sharpness of the image.

Brightness: adjust the brightness of the image.

contrast: adjust the contrast of the image.



5. Preference Page (Note: This menu page will pop up before put the disc into DVD.)

TV Type: Select the local TV system (PAL/NTSC/Auto; Australia uses PAL)

Audio: Disc audio language selection (disc dependent)

Subtitle: Disc subtitle language selection (disc dependent)

Disc Menu: Disc Menu language selection (disc dependent)

Parental: Set the maximum disc rating (G / PG / M etc.) that can be viewed without a password (default password is 0000)

Password: Change the password

Default: Choose this to restore the original default Preference settings

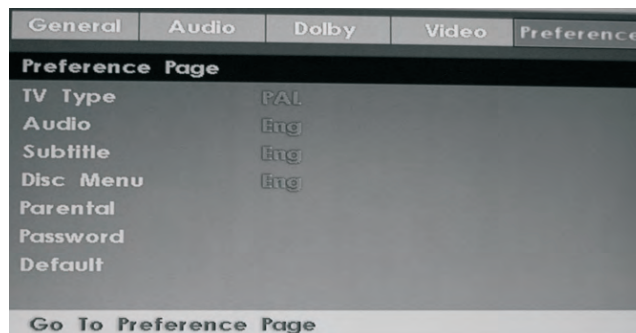

HELP

No Power	<ul style="list-style-type: none"> ● Check the AC Adaptor of LED TV is plug in or not. If still no power, please Pull out the plug and replug in after 60 seconds. And turn on the TV again.
Signal receive not properly	<ul style="list-style-type: none"> ● To cause double image or phantom if there has high building or high mountain round TV. You can adjust image effect by manually operation: consult instruction of vernier regulation or change the direction of external antenna. ● If you use the indoor antenna . under certain circumstance, receive will be more difficult .So you can change the direction of the antenna to adjust the image effect . If can't change image receiving effect either , you have to use external antenna.
No picture	<ul style="list-style-type: none"> ● Check the antenna at the back of LED TV is connected properly or not. ● Try to select other channels and check whether the TV problem itself or not
Video is ok ,but without audio	<ul style="list-style-type: none"> ● Increase the volume. ● Check the TV is in mute mode or not , and please press the mute button to make sound resume.
Audio is ok, but color error or no picture.	<ul style="list-style-type: none"> ● Increase contrast and brightness.
snow statics picture and noise	<ul style="list-style-type: none"> ● Check the antenna at the back of TV is connected or not .
Level broken line	<ul style="list-style-type: none"> ● Maybe has electrical appliance interfere, such as hair drier, vacuum cleaner and so on, please turn off these kinds of electrical appliance.
Dual-Image or "simulacrum" The LED TV no response with the Remote.	<ul style="list-style-type: none"> ● Perhaps the location for the antenna is not good. Use the tall beamed antenna can be improved quality of the display image. ● Operate the remote direct to the remote sensor on the TV. If still no response for the TV, please check if the plastic bag on the remote take or not. And check if the location for the battery is correct. Change the new battery. ● The TV will shift to the STAND BY if no response from the remote in the few minutes.
NO Video In. (PC Mode)	<ul style="list-style-type: none"> ● Please check if the display cable connect to the VGA correcte . ● Please check if there has the bend on the display cable.
Vertical twinkling (PC Mode)	<ul style="list-style-type: none"> ● Enter the main menu, Use the clock regulator for the Video display noise to eliminate the vertical line.
horizontal ripping (PC Mode)	<ul style="list-style-type: none"> ● Adjust the Audio sound horizontal in the main menu to clear the horizontal ripping line.
The screen is too bright or too dark (PC Mode)	<ul style="list-style-type: none"> ● Adjust the contrast ratio or brightness in the main menu.
PC Function no response	<ul style="list-style-type: none"> ● Check the computer setting in the state of compatible display resolution
Ripping line in RCA connecting	<ul style="list-style-type: none"> ● Please use good quality connecting cable.
Problem still exist	<ul style="list-style-type: none"> ● Unplug the power adaptor and wait for 30 seconds, then connect. If there is some problem with our TV, do not repair it by yourself, please contact with the customer service center.

Note: There will be complete picture and the brightness will come down if the TV is in the static picture for too long time, So please do not keep the TV in a state of same Menu or same picture that has much difference in brightness and contrast ratio for too long time.

Support importation signal format

VGA

Resolution	640x480	800X600	1024x768	1360x768	1920x1080
Vertical frequency hz	60HZ	60HZ	60HZ	60HZ	60HZ

HDMI

Format	480 i/P	576 i/P	720 P	1080 i/p
Vertical frequency hz	60HZ	50HZ	50HZ/60HZ	50HZ/60HZ

Parameter specification

Screen Size	24"
TV system	NTSC / ATSC
Video system	PAL, NTSC
Preset Channels	AIR:2-69 CABLE:1-135
Input/Output	IN:TV, AV, YPBPR, PC AUDIO, VGA, HDMI. OUT: COAXIAL, EARPHONE.
Speaker Output	3W+3W
Power requirement	DC 12V \Rightarrow 4A
Power consumption	48W
Accessories	User's manual Remote controller AC adapter 2 x AAA Batteries

NOTE:

This user's manual is for reference only. Specifications are subject to change without notice